



Celle® Chairs







## **Celle Chairs.**

### **Durable design, ergonomics, unique appearance.**

The Celle chair looks different from other work chairs because it is different. It's the only chair that has Cellular Suspension™, a durable system of cells and loops that properly distributes weight. Cellular Suspension also lets air pass through, another factor in the all-day comfort that Celle provides.



One chair size fits the 5th percentile female to 95th percentile male. Celle is a global chair, meeting ergonomic standards and codes worldwide. Shown in Cabernet seat and back with Graphite base and frame.



## An idea takes off.

When Jerome Caruso imagined Celle, he envisioned something brand new—intelligently pliable seat and back surfaces that know how to respond properly when you sit down, work, and move. Caruso patented his innovation and named it Cellular Suspension™ because the surface is composed of small pads, which he called cells. He connected the cells with springy loops. Caruso likens the suspension's effect to buoyancy. Water supports you as you float, forming and reforming as you move.

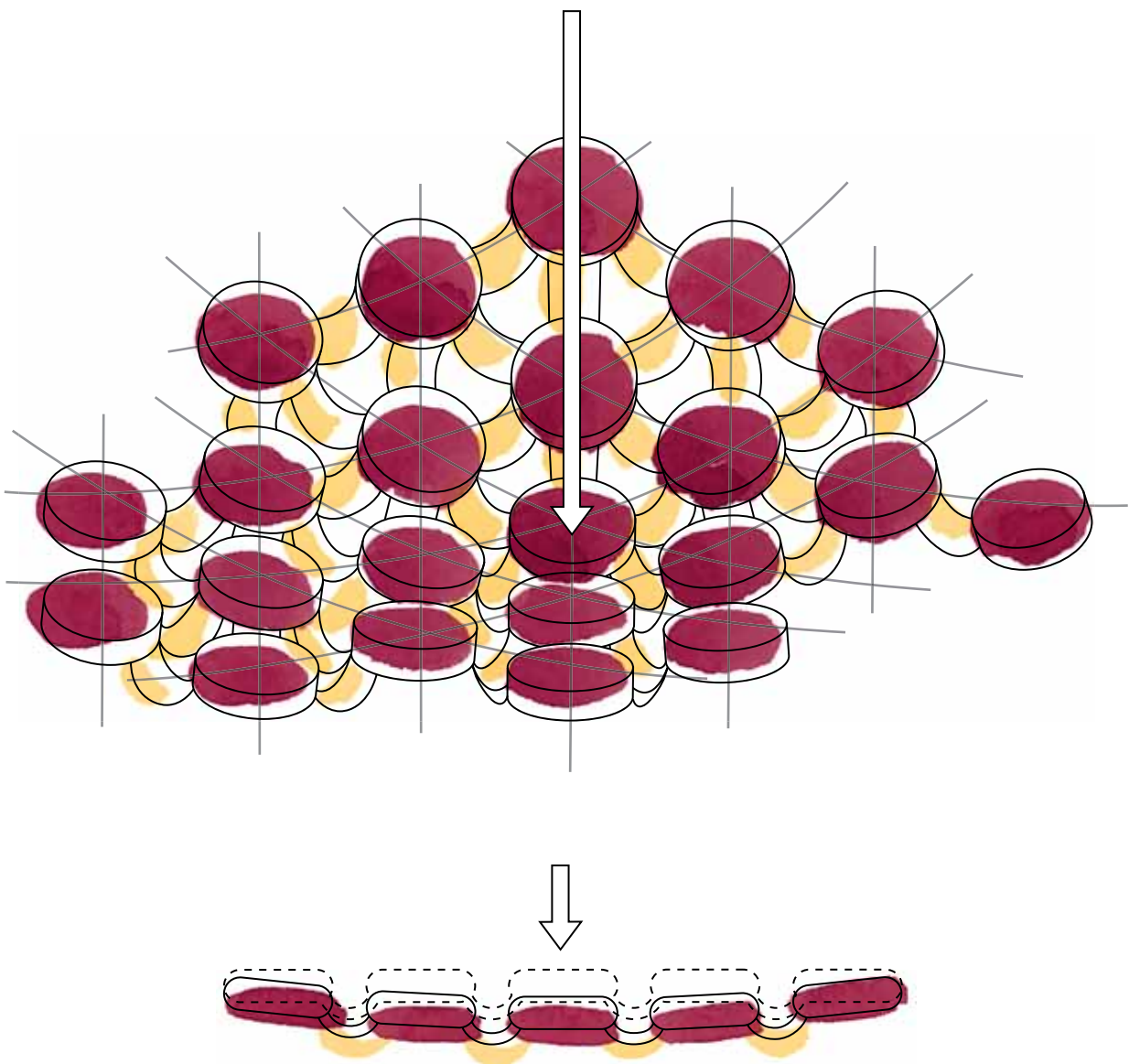

## Targeted flex.

By varying the loop depths, we engineered different levels of flex throughout the seating surface. That let us target different areas of a person's body with the right amount of give. And no two of Celle's 1,578 cells are alike. Each is contoured to follow the chair's healthful curves, including a passive PostureFit, for exceptional lower-back support. This was accomplished with the simplest of materials: Polypropylene.

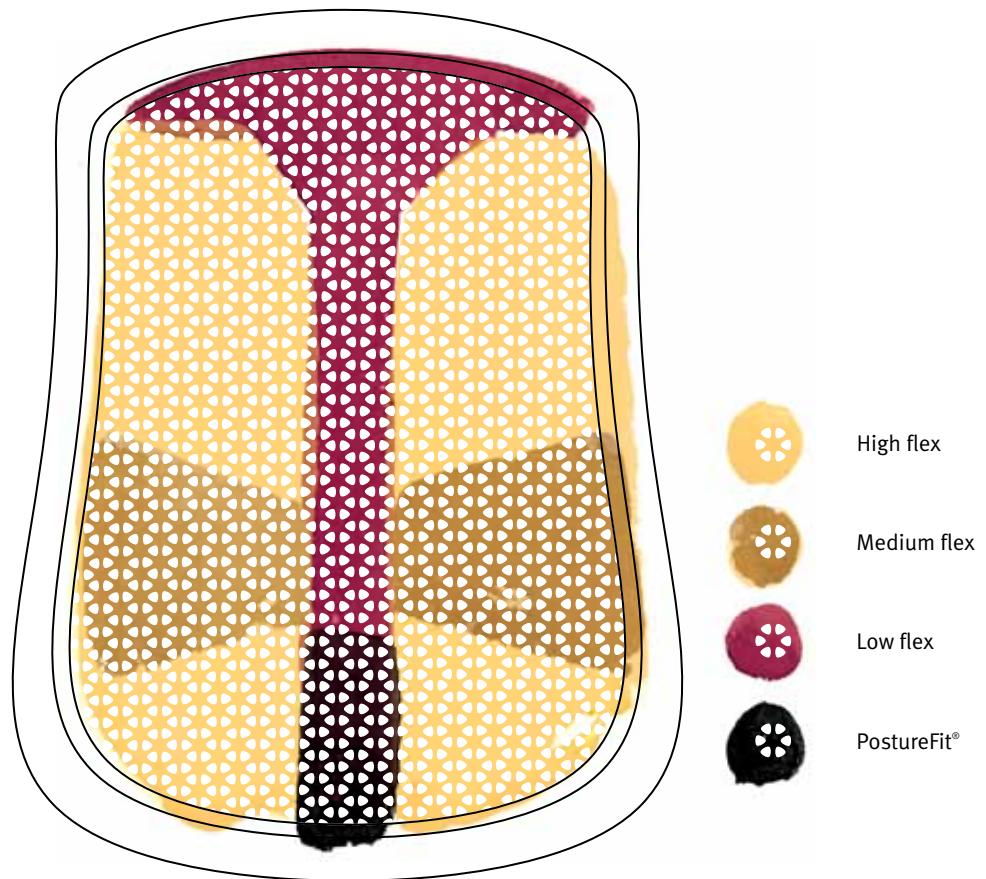

## Comfort in motion.

To complement the natural support of the Cellular Suspension, Celle incorporates Herman Miller's patented Harmonic™ tilt. The synchronous, calibrated mechanism lets you move naturally through the chair's wide, 28-degree recline range. Without effort, you stay balanced and feel in control.

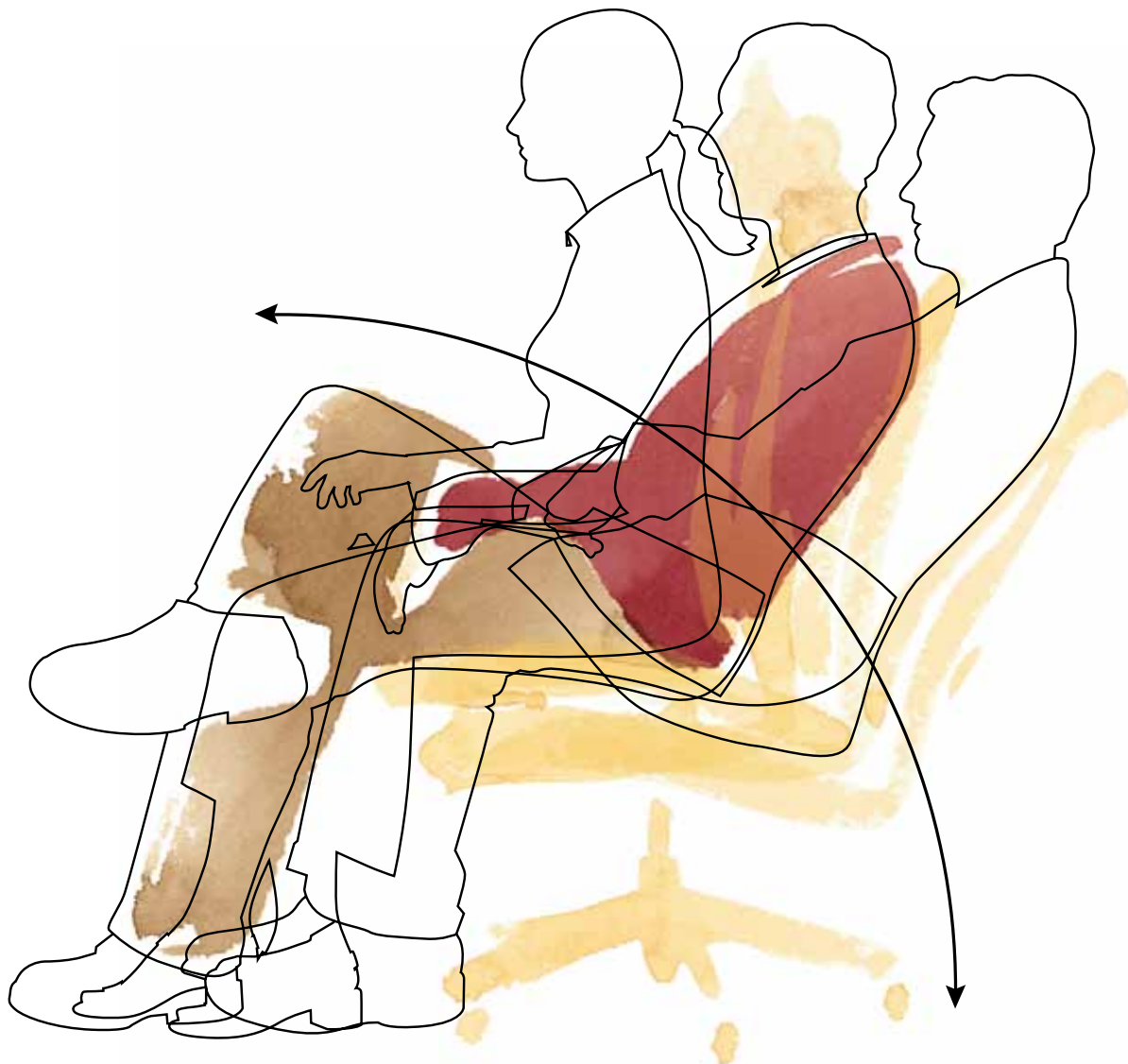



*Celle fully upholstered*

The Celle fully upholstered chair features a foam cushion seat for added comfort.

## For people everywhere.

Celle offers a wealth of adjustments with generous ranges: pneumatic seat height, tilt tension, lumbar support, seat depth, arm height / width / pivot, tilt limiter, forward seat angle.

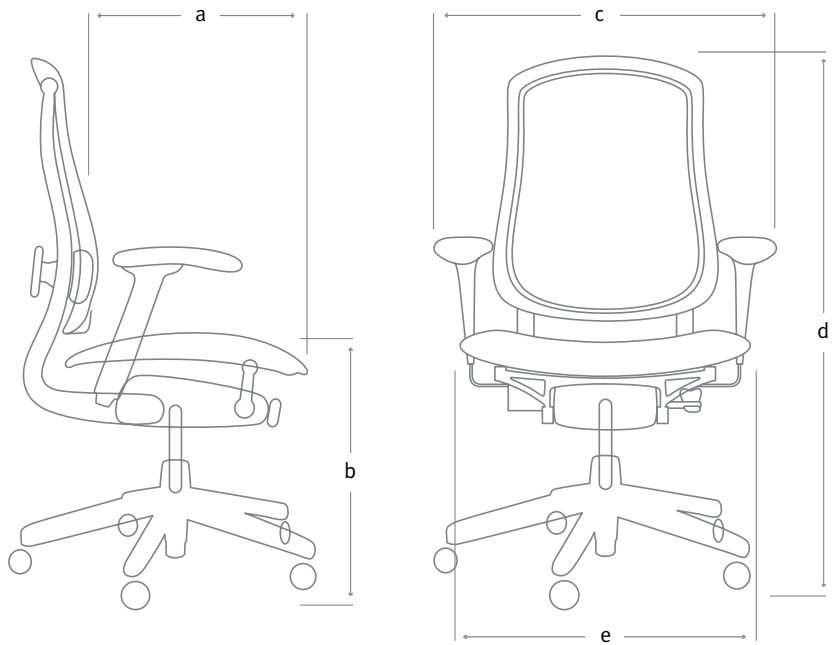
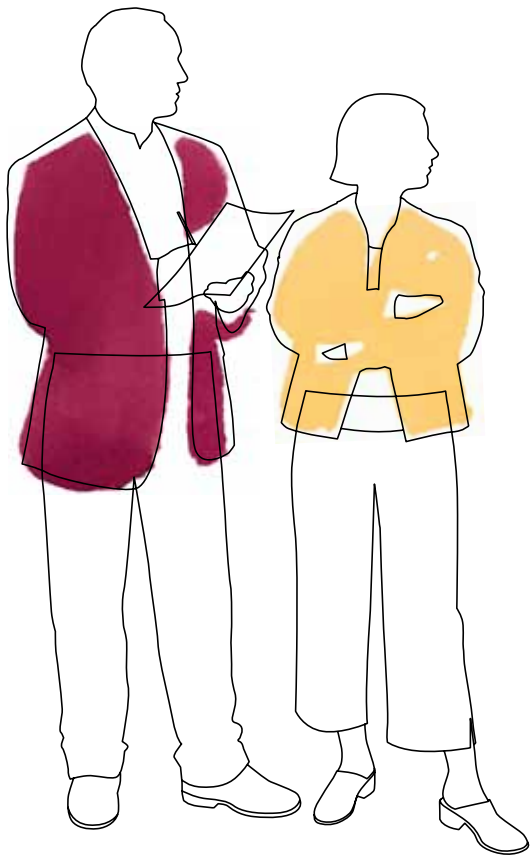

	Low-height-range	Standard-height-range	Extended-height-range
a	394-457	394-457	394-457
b	381-483	394-514	419-540
c	749	749	749
d	1,105 max	1,118 max	1,143 max
e	508	508	508

All dimensions are in millimetres.



## Green initiative.

We made Celle good for the sitter. We also made it good for the earth. Like every product we develop, it meets our demanding environmental protocol:

Recyclable—99 percent; optional Latitude™ fabric, 100 percent.

Disassembly for recycling—Takes less than 5 minutes.

Waste minimisation—  
Manufacturing is ISO-14001 certified.

Packaging—All reusable or recyclable.

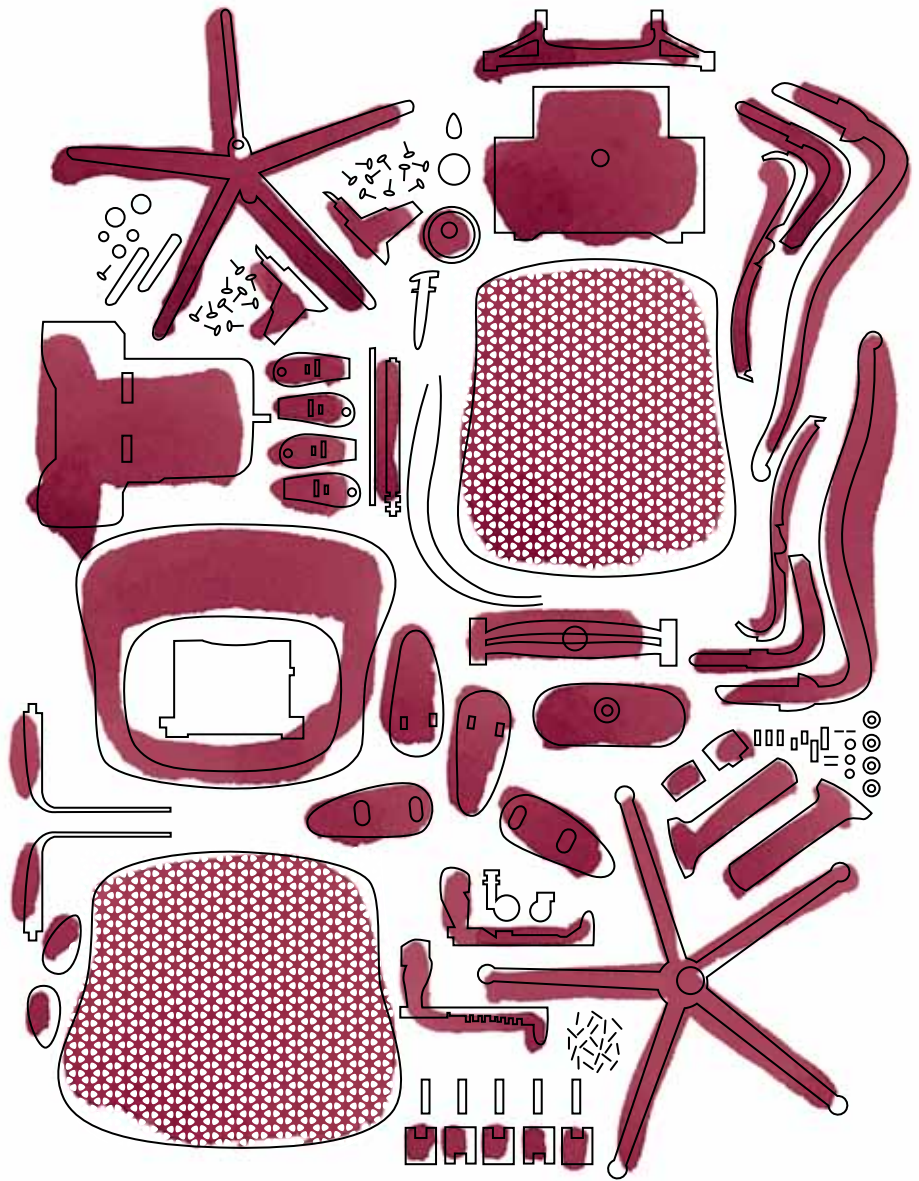



With its transparency, colour range and uncluttered form, Celle blends in. It lets other furniture and architecture have the spot light. So Celle works throughout office, healthcare and learning settings.



Cellular Suspension™



Complete Back Support



Convenient Controls



Upholstered Seat Option









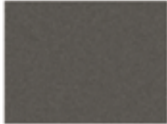

Full Range of Adjustments

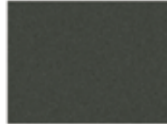

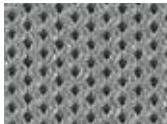
## Colours, materials and finishes.

Celle complements interiors with a molded-polymer seat and back with an open pattern that lets light and air through. Colours span dark to light, neutral to nature based.

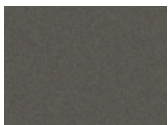

### Seat & Back

Finish						
	Blue Fog ZN	Brownstone 3G	Cabernet XG	Champagne DM	Graphite G1	Green Leaf RN
Latitude						
	Graphite 8M01	Shadow 8M02	Citron 8M03	Felt Green 8M04	Blue Fog 8M05	Cappuccino 8M06
						
	Terra Cotta 8M07	Alpine 8M10	French Blue 8M12	Midnight Blue 8M13	True Red 8M14	Champagne 8M15
						
	Chestnut 8M16	Black 8M17	Brownstone 8M18	Green Leaf 8M19	Cabernet 8M20	

### Base & Frame

Finish		
	Brownstone 3G	Graphite G1

### Armpads

Finish		
	Brownstone 3G	Black BK

Samples are representative of the material to be supplied and may not indicate an exact match; some variation may occur.

For more information about our products and services or to see a list of dealers, please visit us at [hermanmiller.com/worldwide](http://hermanmiller.com/worldwide) or call +44 845 2267201

PB1699

Herman Miller and  are registered trademarks of Herman Miller, Inc. Celle, Cellular Suspension, Harmonic and Latitude are trademarks of Herman Miller, Inc.

 **HermanMiller**

